



Stylo

EXTERNAL
OPERATOR FOR
SMALL AND
MEDIUM SWING
GATES



CAME

Stylo

**Small in size
but great in
performance**



Narrow, compact with an exclusive design, Stylo is the new solution for small and medium size swing gates. Easy to install even on pre-existing gates or without any prior preparation, and on very narrow pillars. The best of Came technology and safety concentrated in just a few centimetres.



Reasons to choose Stylo

MAXIMUM POWER IN JUST 8 CM.

Easy to install on pre-existing or new gates, Stylo is ideal to automate pedestrian or driveway gates up to 1.8 m per leaf.

Tested in compliance with European regulations relative to impact force, it can be installed on small and medium sized pillars, from just 10 cm wide.

It is easily installed without any hidden costs, making the installer's work easier and speeding up the issue of the Compliance Certification.

STRONG POINTS:

Faster work **for the installer** with no need for any structural work. Stylo occupies a minimum amount of space and is very flexible and adaptable to the majority of small and medium size gates: it is easily installed even on narrow pillars without any masonry work required. The exclusive EN Tested technology guarantees high safety standards in compliance to the strict European regulations. This enables professional installers to streamline certification procedures, offering a totally safe automation.

Users are guaranteed maximum comfort and reliability, and are able to automate their gates in complete safety without any invasive or costly jobs to perform, even in unsuitable conditions. The appearance of the gate remains unchanged and its movements are always modern and efficient.

ARTICULATED OR STRAIGHT, PERFECT RESULTS.

Two different types of arm are available depending on the type of application. Stylo is available with an articulated or straight "slide" transmission arm. Came suggests this alternative where there is very little space available, especially against lateral walls and fences.

STYLO, THE SIMPLE
MODERN AUTOMATION
FOR GATES.



External motor that is ideal for even small pillars.

WITH STYLO, RESTRICTED
SPACES ARE NO LONGER A
PROBLEM.



Stylo

electronics and technology

In addition to its standard command and safety functions, Stylo's new electronics bring numerous new features that enable total control of the automation and unique optimisation of the service.

Display to view function programming.

Warning **leds** built-into the control board provide quick diagnosis of the system.

Self-diagnosing of safety devices.

ENCODER-based **electronics manage** for obstacle detection.

ENCODER-based **endstop control** to easily management movement and slow-down phases.

Simplified installation: requires only one four-conductor cable to handle power source and slow-downs.

Memorisation of the transmitters using different codes (up to 250 users).

MADE IN ITALY, MADE IN CAME.

The 100% Made in Italy originality mark testifies that Stylo, like the rest of the Came product range, stems from a quality manufacturing process, engineered to generate technologically reliable and efficient products. These are tested for wear and tear for an equivalent period of 10 to 15 years of intense activity. They are also tested for extreme temperature resistance (lows of -40°C to highs of +80°C). Specific tests also check how the device functions with any electromagnetic interference.

That is why, if properly installed, Style lasts longer and is problem-free even in severe weather conditions. All this means authority and prestige to the installer, and safety and peace of mind to the user.

INTENSIVE USE, BLACKOUTS GOODBYE.

The 24 V motor is perfect for intensive use conditions. Not only: in case of blackouts Stylo's ZL92 electronics automatically detect the power cut and activate the auxiliary, optional emergency batteries, which always guarantee that the gate can be opened or closed.

EN TESTED: NO COMPROMISE WHEN IT COMES TO SAFETY.

Stylo is EN Tested automation, that is, it has been manufactured and tested according to the rigorous criteria set out by current European Regulations concerning impact force. Thanks to this, the device can readily be certified on site by installers.

Essentially, the electric lock incorporated in the motor guarantees safe closing and can only be released using the customised key.





Stylo also has an additional safety system which monitors gate-leaf movement via the ENCODER electronics (Hall sensor and polarised magnet).

Any contact with possible obstacles, immediately inverts the direction of movement.



The Stylo range

24 V DC external operator and control panel - tested in compliance with EN 12453 - EN 12445

001 STYLO-ME	Self-locking operator with encoder for gate leaves of up to 1.8 m / 6 ft.	  
002 ZL92	Control panel for two-leaf swing gates with function programming display, self-diagnosing safety devices and built-in radio decoder	 

Accessories for: 002ZL92

002 LB90	Card for connecting n. 2 12V – 1.2 Ah emergency batteries.	
-----------------	--	---

Accessories

001 STYLO-BS	Articulated transmission arm.
001 STYLO-BD	Straight transmission arm and slide guide.

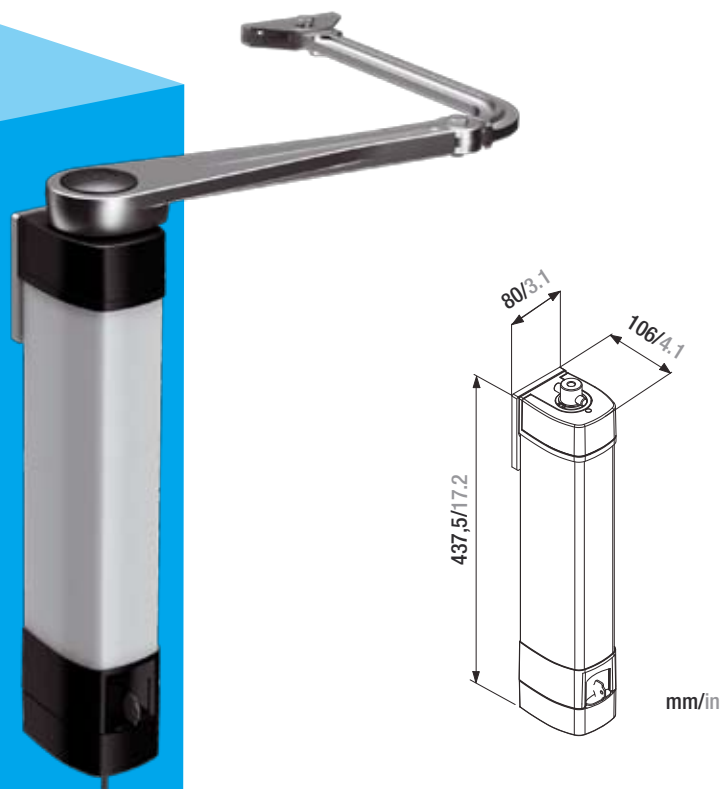

Limits to use

MODEL	STYLO-ME		
Max width of gate leaf (m/ft)	1,8/6	1,293.9	0,8/2.6
Max weight of gate leaf (Kg/lb)	100/220	125/275	150/330
Max opening of gate leaf (°)	120 (with 001STYLO-BS) 135 (with 001STYLO-BD)		

● 24 V DC

Technical features

TYPE	STYLO-ME
Protection rating	IP54
Power supply (V - 50/60 Hz)	230 AC
Motor power supply (V - 50/60 Hz)	24 DC
Current draw (A)	5 MAX
Power (W)	48
90° opening time (s)	ADJUSTABLE
Duty cycle (%)	INTENSIVE USE
Thrust (Nm)	100
Operating temperature (°C)	-20 ÷ +55
Motor's thermo-protection (°C)	-

● 24 V DC

**FIND OUT WHAT'S
NEW WITH CAME**
from your wholesaler
or from came.com



PRODUCTS



Came cancelli automatici s.p.a.

Via Martiri della Libertà, 15
31030 Dosson di Casier
Treviso - Italy
Tel. (+39) 0422 4940
Fax (+39) 0422 4941
info@came.it
www.came.com



CAME